



***Giga Metals Announces Positive PFS for the  
Turnagain Nickel-Cobalt Project***



# Disclaimer

This presentation ("Presentation") is being issued by Giga Metals Corporation (the "Company" or "Giga Metals") for information purposes only. Reliance on this Presentation for the purpose of engaging in any investment activity may expose an individual to a significant risk of losing all of the property or other assets invested. Technical information in this presentation has been approved by Lyle Trytten, P.Eng., the Company's Manager of Development and a Qualified Person as defined by NI 43-101. Financial modelling used herein is based on the [Pre-Feasibility Study \(PFS\)](#) filed by the Company in October 2023. The PFS is preliminary in nature and there is no assurance the mining, metal production or cash flow scenarios outlined in this Presentation would ever be realized. This Presentation is not intended to and does not constitute an offer to sell or the solicitation of an offer to subscribe for or buy or an invitation to purchase or subscribe for any securities where such offer would be illegal, nor shall there be any sale, issuance or transfer of securities in any jurisdiction in contravention of applicable law. No offer of securities shall be made except pursuant to applicable prospectus exemptions and the securities laws related thereto.

## **Forward looking statements**

Certain statements in this Presentation are forward-looking statements, which reflect the expectations of management regarding the Turnagain Project. Forward-looking statements consist of statements that are not purely historical, including any statements regarding beliefs, plans, expectations or intentions regarding the future. Any statements that express or involve discussions with respect to predictions, expectations, beliefs, plans, projections, objectives or future events or performance (often, but not always, using words or phrases such as "seek", "anticipate", "plan", "continue", "estimate", "expect", "may", "will", "project", "predict", "forecast", "potential", "target", "intend", "could", "might", "should", "believe" and similar expressions) are not statements of historical fact and may be "forward-looking statements". Such statements in this Presentation include, but are not limited to, statements with respect to the future potential economic viability of the Project, the estimation of mineral resources, mineral reserves and mineral prices, steps to be taken towards commercialization of the Project, the demand for nickel supply, the impact of the Inflation Reduction Act, the growth of electric vehicle sales, future global nickel production; the timing and amount of estimated future production and capital, operating and exploration expenditures and include, for greater certainty, all estimates in the PFS such as the cash, flow, IRR, NPV's, initial capital, sustaining capital, operating costs and life of mine production. Such statements are subject to risks and uncertainties that may cause actual results, performance or developments to differ materially from those contained in the statements. No assurance can be given that any of the events anticipated by the forward-looking statements will occur or, if they do occur, what benefits the Company will obtain from them. These forward-looking statements reflect management's current views made in light of management's expertise and are based on certain expectations, estimates and assumptions which may prove to be incorrect. A number of risks and uncertainties could cause our actual results to differ materially from those expressed or implied by the forward-looking statements, including: (1) the mineral resource and mineral reserve estimates relating to the Project could prove to be inaccurate for any reason whatsoever, (2) the Company may be unable to obtain financing for the Project on acceptable terms or at all, (3) prices and demand for nickel, cobalt, battery products and electric vehicles could decline, (4) Project costs could differ substantially from those anticipated in the PFS and make any commercialization uneconomic, (5) inferred and indicated resources may not materialize, (6) permits, environmental opposition, government regulation, cost overruns or any of many other factors may prevent the Company from commercializing the Project, (7) additional but currently unforeseen work may be required to advance to the feasibility stage, (8) new sources of nickel may be discovered, (9) battery technology may change, (10) legislative changes (both globally and within Canada) may occur which impact the demand for battery metals and the feasibility of the Project, and (11) even if the Project goes into production, there is no assurance that operations will be profitable. These forward-looking statements are made as of the date of this Presentation and, except as required by applicable securities laws, the Company assumes no obligation to update these forward-looking statements, or to update the reasons why actual results differed from those projected in the forward-looking statements. Additional information about these and other assumptions, risks and uncertainties are set out in the "Risks and Uncertainties" section in the Company's most recent MD&A filed with Canadian security regulators.

# Giga Metals and Mitsubishi Corporation (MC) Turnagain Project Joint Venture

- Hard Creek Nickel Corp. is the JV company
- MC owns 15% interest, Giga maintains 85% ownership
- Giga and MC will jointly advance the Turnagain project as one of the lowest carbon and most environmentally friendly nickel projects globally
- Pre-Feasibility Study completed in October 2023



# 2023 PFS Highlights

**37,288 t/y Ni+Co**

Typical annual output

**30 year**

Project life

**18% Ni, 1.1% Co**

High Grade Concentrate

**US \$1.9B**

Initial Capital Cost

**US\$3.85/lb Ni**

Site operating cost (Y3-28 average)

**US\$4.65/lb Ni**

C1 cost (Y3-28 average)



# Technical Highlights

## **SIMPLE FLOWSHEET**

Crush – grind – froth flotation

## **SUCCESSFUL GEOMET PROGRAM**

High-precision recovery algorithm  
fits all ore types

## **MULTIPLE PRODUCT PATHS**

Smelting or POX to Class 1 nickel

## **LARGE OPEN PIT MINE**

Very low strip ratio (0.4:1 LOM)

## **LOW CARBON OPERATION**

<1.8 t CO<sub>2</sub>/t Ni in concentrate,  
pathway to carbon-neutrality

## **TAILINGS SEQUESTER CO<sub>2</sub>**

Center-line facility, mineral  
carbonation

# Located in an Attractive Mining Jurisdiction

- Strong ESG practices
- Access to a deep-water Pacific ports and North American rail
- The Turnagain project is located in joint **Tahltan** and **Kaska Dena Territory**
- Both nations are generally supportive of responsible mining development

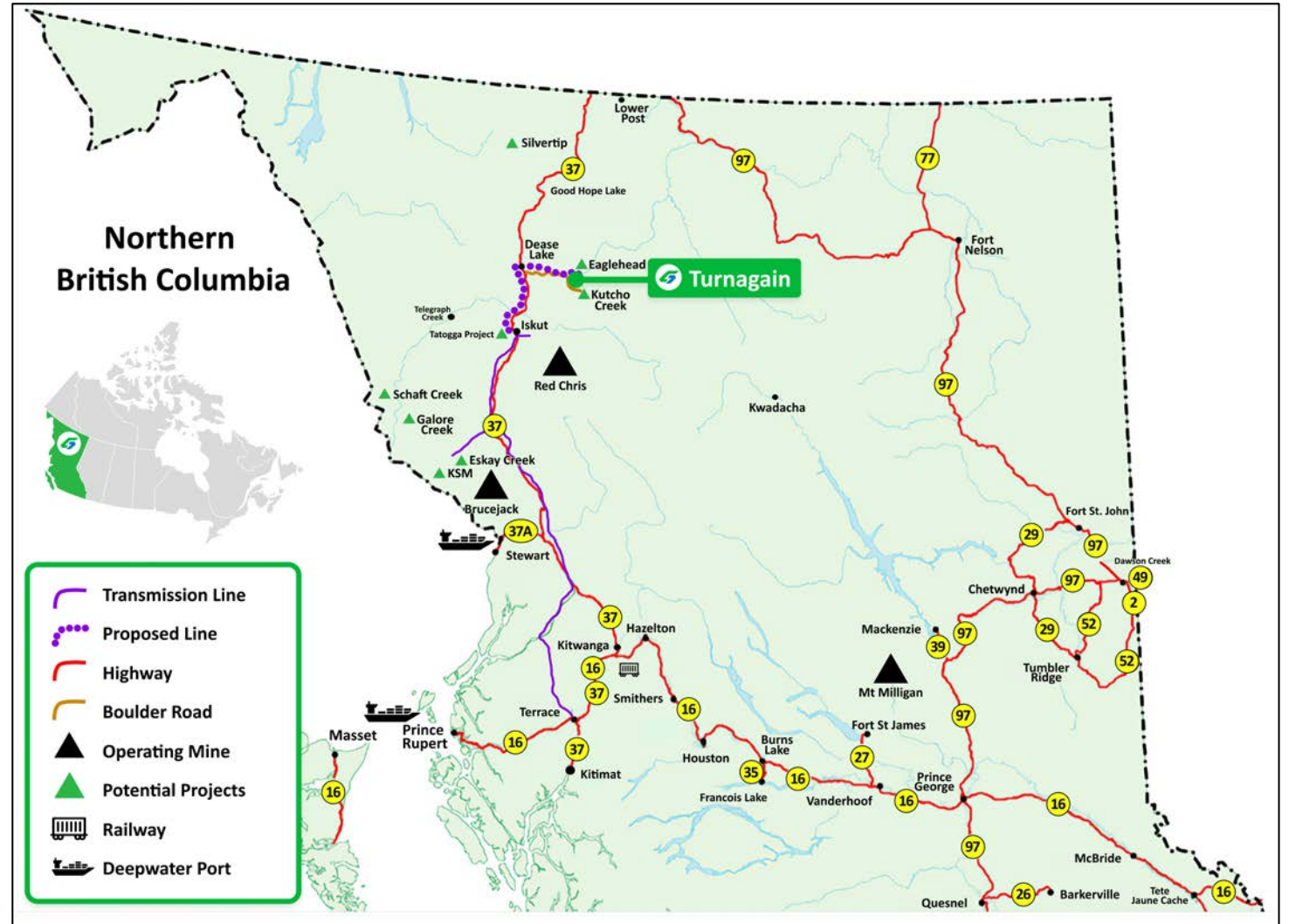

# Mineral Reserves Statement

Classification	Tonnage (Mt)	Ni Grade (%)	Contained Ni (million lbs)	Co Grade (%)	Contained Co (million lbs)
Proven	408	0.219	1,970	0.013	121
Probable	542	0.194	2,326	0.012	146
<b>Total</b>	<b>950</b>	<b>0.205</b>	<b>4,296</b>	<b>0.013</b>	<b>267</b>

*The Mineral Reserve estimates were prepared with reference to the 2014 Canadian Institute of Mining, Metallurgy and Petroleum (CIM) Definition Standards (2014 CIM Definition Standards) and the 2019 CIM Best Practice Guidelines. Reserves estimated assuming open pit mining methods. Reserves are reported on a dry in-situ basis. Reserves are based on a Nickel price of US \$21,500/t, Cobalt price of US \$58,500/t, ore mining cost of \$2.24/t mined, waste mining cost \$2.41/t mined, mining sustaining capital of \$0.57/t mined, milling costs of \$5.35/t feed, TMF sustaining capital of \$0.70/t feed, and G&A cost of \$0.76/t feed. Mineral Reserves are mined tonnes and grade; the reference point is the processing plant feed at the primary crusher and includes consideration for a 2 m dilution width between ore-waste contact and mining losses of 1%. Ore-waste cut-off was based on \$6.63/t of NSR. **This is an abbreviated Reserves Statement, please see the website for the full table.***



# Mineral Resources Statement

Classification	Tonnes (million)	Ni Grade (%)	Contained Ni (million lbs)	Co Grade (%)	Contained Co (million lbs)
Measured & Indicated	1,574	0.210	7,454	0.013	452
Inferred	1,164	0.206	5,302	0.012	316

All mineral resources have been estimated in accordance with Canadian Institute of Mining and Metallurgy and Petroleum definitions, as required under National Instrument 43-101. Mineral resources are reported in relation to a conceptual pit shell in order to demonstrate reasonable expectation of eventual economic extraction, as required under NI 43-101; mineralisation lying outside of these pit shells is not reported as a mineral resource. Mineral resources are not mineral reserves & do not have demonstrated economic viability. Open pit mineral resources are reported at a cut-off grade of 0.1% Ni. Cut-off grades are based on a nickel price of \$9.00 per pound, nickel recoveries of 60%, mineralized material and waste mining costs of \$2.80, along with milling, processing and G&A costs of \$7.20. Inferred mineral resources are considered too speculative geologically to have economic considerations applied to them that would enable them to be categorised as mineral reserves. However, it is reasonably expected that the majority of inferred mineral resources could be upgraded to indicated. Due to rounding, numbers presented may not add up precisely to the totals provided and percentages may not precisely reflect absolute figures. **This is an abbreviated Resources Statement, please see the website for the full table.**



# Ultramafic Intrusive Exploration Targets

- The Turnagain deposit is open to expansion
- Other than the Horsetrail Zone, the Turnagain Intrusive remains underexplored

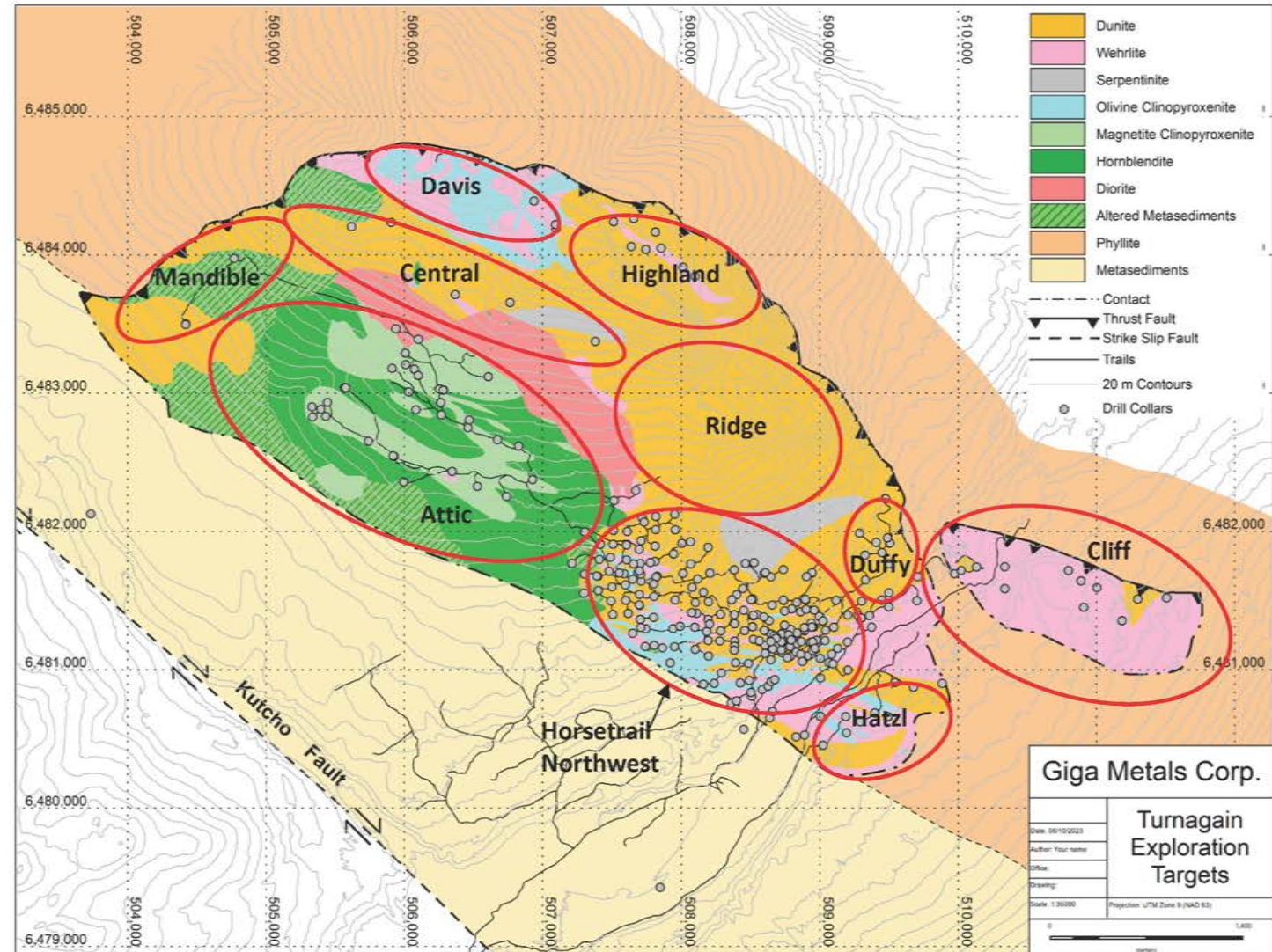

# Simplified Processing Flowsheet

- Processing plant will be installed in slightly offset stages to maximize efficiency of construction and commissioning.
- Primary crusher is located adjacent to the mine to reduce haul distances
- Main processing facility including secondary and tertiary crushing, grinding, and flotation located above the TMF

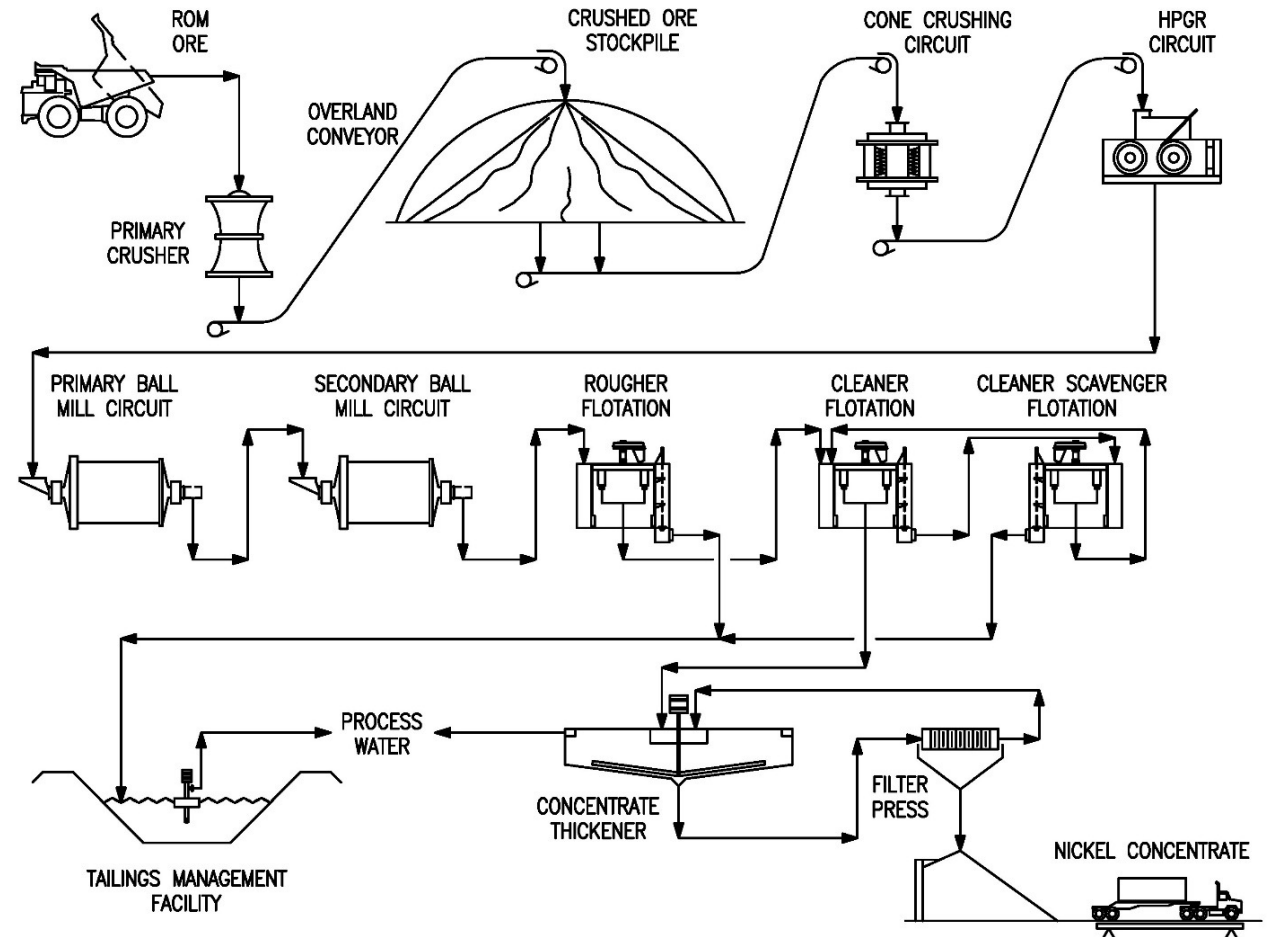

# High Grade Clean Concentrate

- Desirable nickel sulphide concentrate product
- Multiple testwork campaigns: 15 to 21% Ni.
- Low impurities such as arsenic, mercury, cadmium
- Suitable for PFS Base Case – smelting
- Suitable for direct pressure oxidation to produce refined nickel end products such as battery chemicals
  - Sherritt, BHP, Vale have built direct refining operations
- Project has **flexible options** for concentrate sale/treatment





# Projected Yearly Metal Production at Turnagain

Average years 3-28:

**35,224 t/y Nickel**

**2,064 t/y Cobalt**

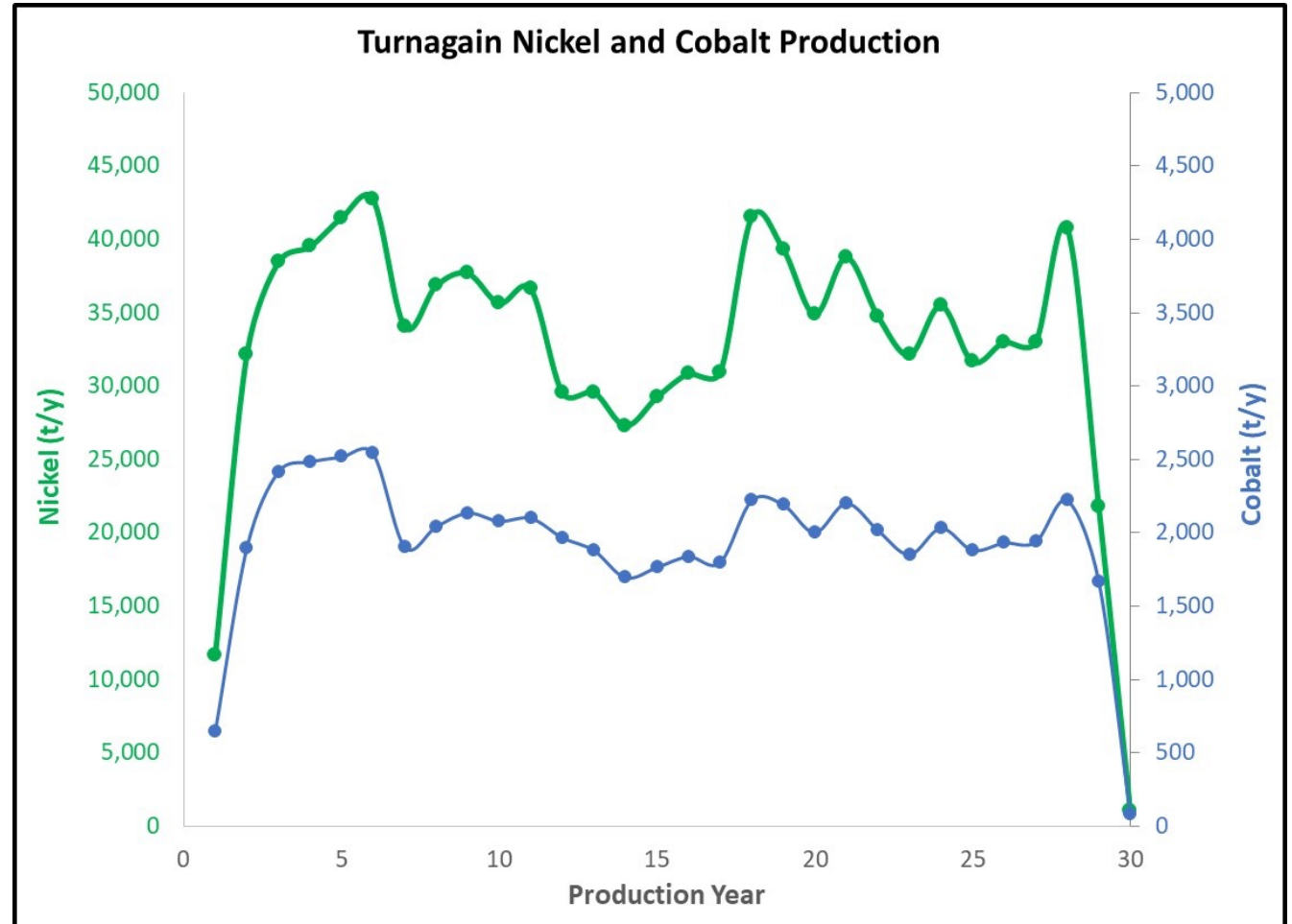



# North American Battery Projects

- The supply chain for new giga factories is not yet resolved
- **250,000 to 450,000 t/y** of new nickel supply is needed to feed announced battery projects in North America alone
- Actual demand depends on LFP vs. nickel-rich chemistries and further project announcements

## NORTH AMERICAN BATTERY INITIATIVES

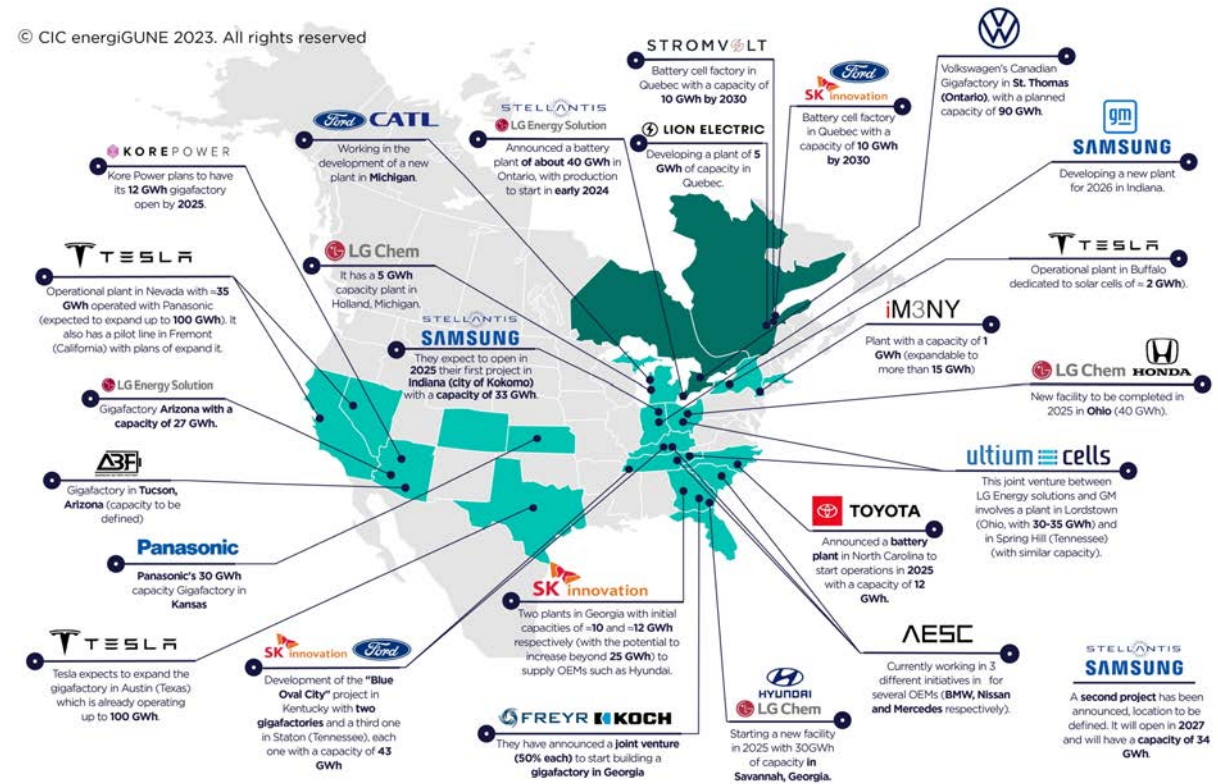

# North American Nickel Operations

- Canada has nickel mines, smelters, and refineries, all targeting Class 1 nickel.
- Most current global production is unsuitable for batteries.
- In 2021, total refined production of nickel in North America was only 102,000 tonnes
- Not all production is suitable for North American EVs

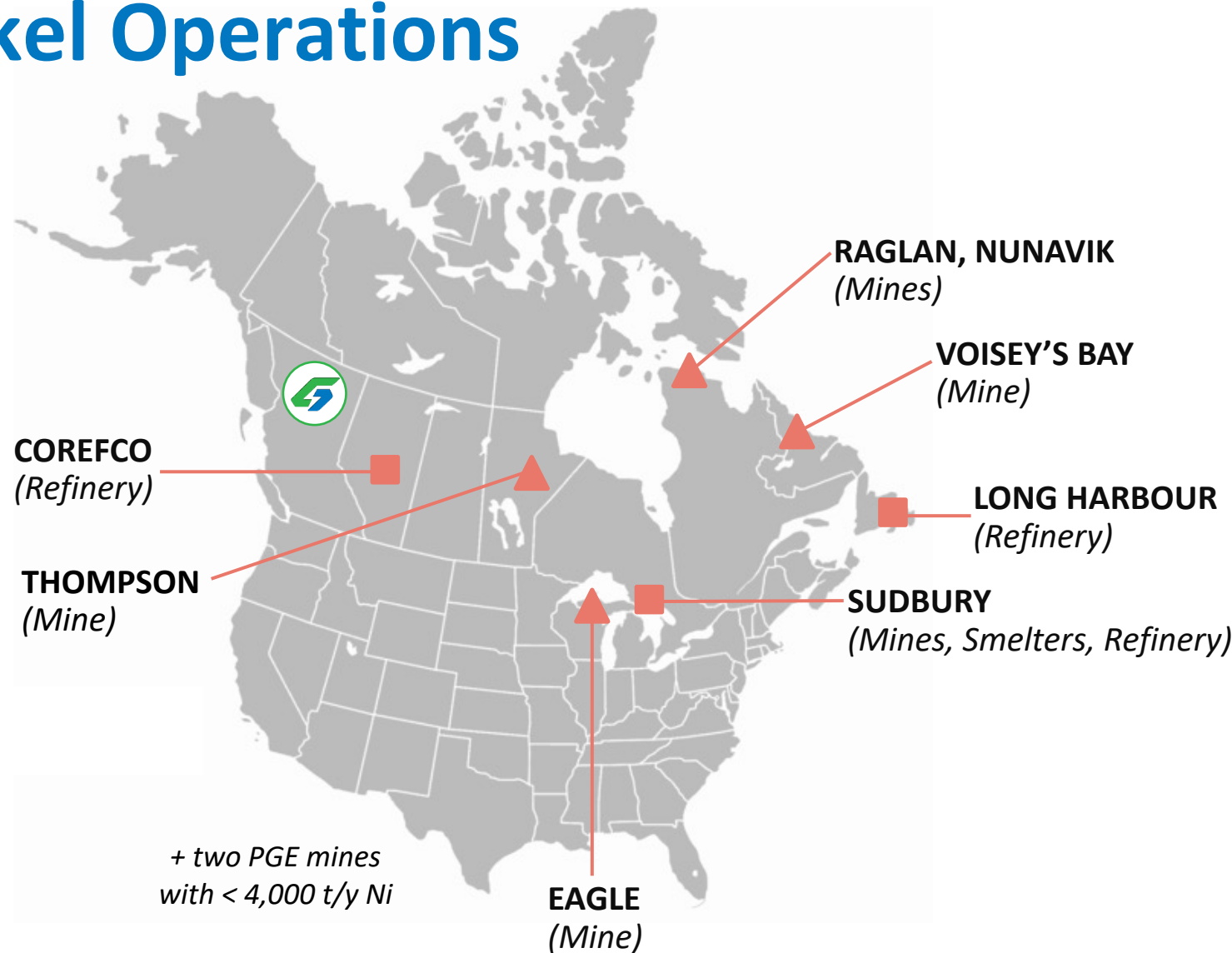

# Inflation Reduction Act Supports Battery Metals

- Announced in August 2022, the Inflation Reduction Act (IRA) aims to ensure more **battery components are mined, refined or processed in the U.S. or by free trade allies (FTA).**
- The goal is to reduce dependence on Chinese critical minerals, both Indonesia and China are NOT free trade allies
- At least 50% of battery components of electric vehicles seeking tax credits in the United States must be finally assembled in North America, and this rises to 100% by 2029

Free Trade Agreement countries and prospective critical minerals partners

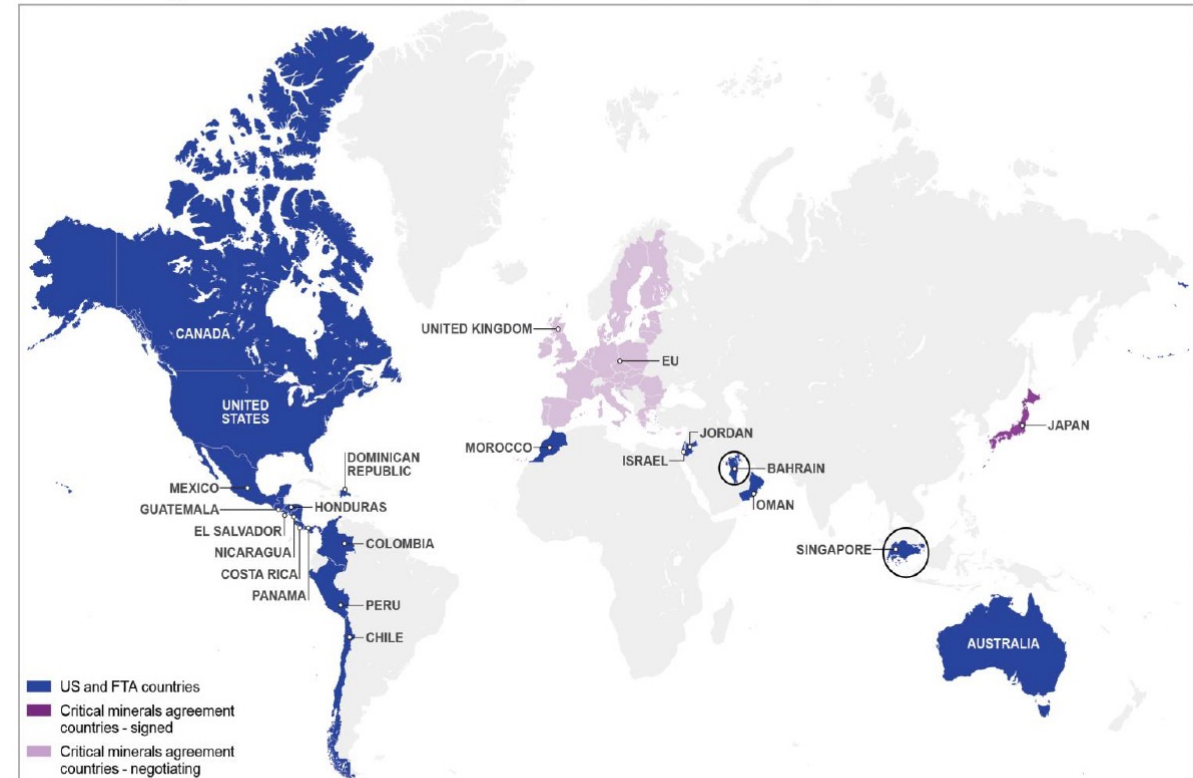

Data compiled Aug. 8, 2023.  
Source: S&P Global Market Intelligence: 2010495.  
© 2023 S&P Global. All rights reserved. Provided "as is", without any warranty. This map is not to be reproduced or disseminated and is not to be used nor cited as evidence in connection with any territorial claim. S&P Global is impartial and not an authority on international boundaries which might be subject to unresolved claims by multiple jurisdictions.

# Impact of IRA on North America

- The IRA is expected to increase the US energy transition demand for nickel from 607 kt in 2035 to **695 kt/y (20x 2021 demand)**
- Energy-transition related US demand for the critical minerals lithium, nickel and cobalt, taken together, will be **23 times higher in 2035** than it was in 2021.
- EVs, as well as IRA tax credits, contribute to expected strong growth in EV sales in the United States. This leads to **projected growth in EV battery demand of 24% year over year** between 2021 and 2035.

US EV battery demand by cathode  
GWh

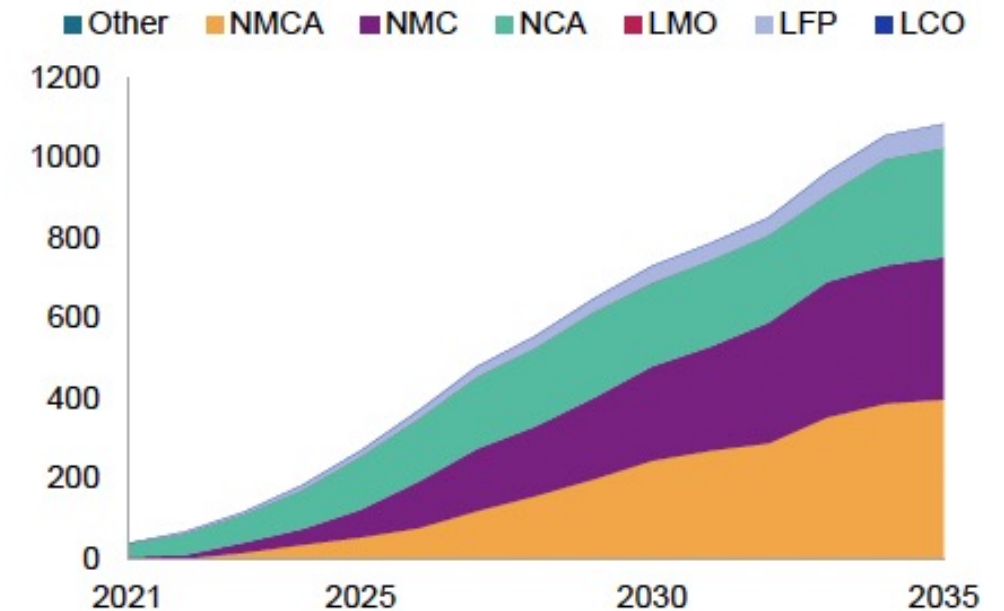

Data compiled February 2023.

LCO = lithium cobalt oxide; LFP = lithium iron phosphate; LMO = lithium manganese oxide; NCA = nickel cobalt aluminum; NMC = nickel manganese cobalt; NMCA = nickel manganese cobalt aluminum. Excludes PHEV and HEV.

Source: S&P Global Commodity Insights, S&P Global Mobility.



# Major Global Demand Growth for Nickel in Batteries

## 3.3 Mt/y<sup>1</sup>

of increased nickel demand forecasted for battery applications by 2040.

## 120<sup>1</sup>

new large nickel projects would be needed by 2040 to meet this demand.

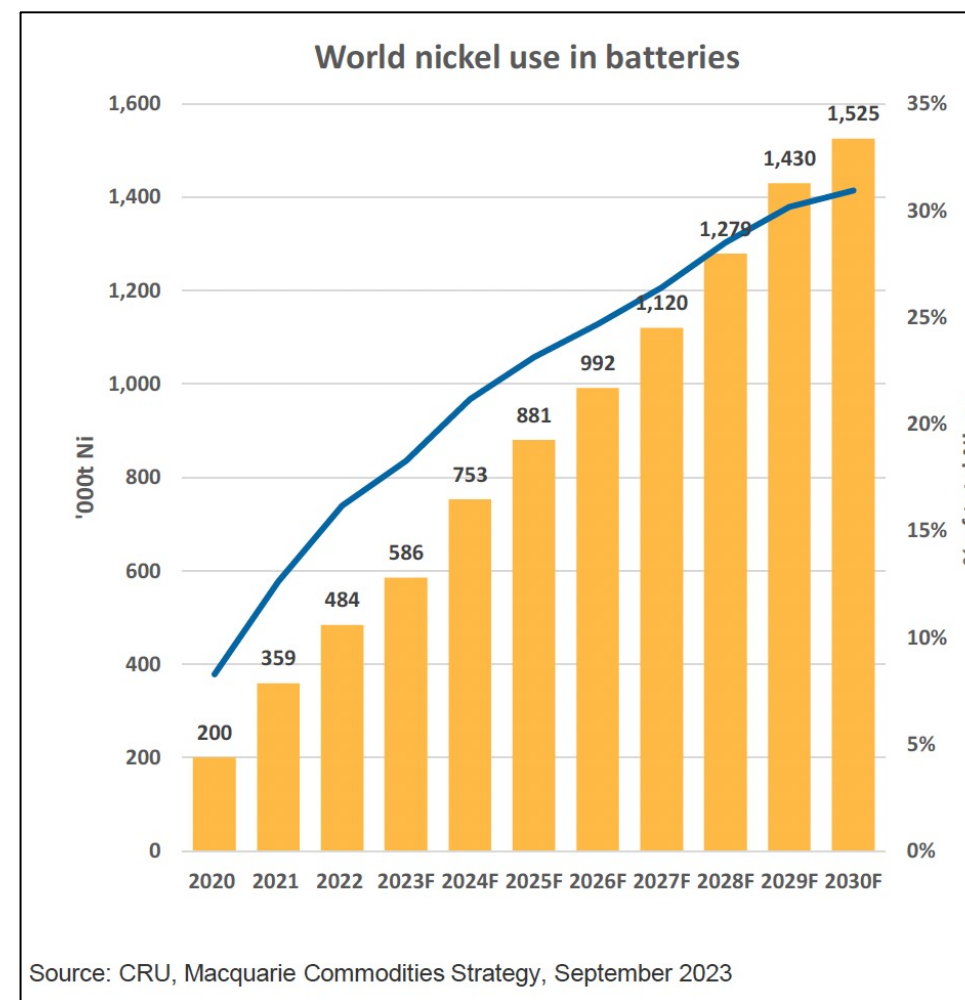

# Nickel Prices are Historically Volatile

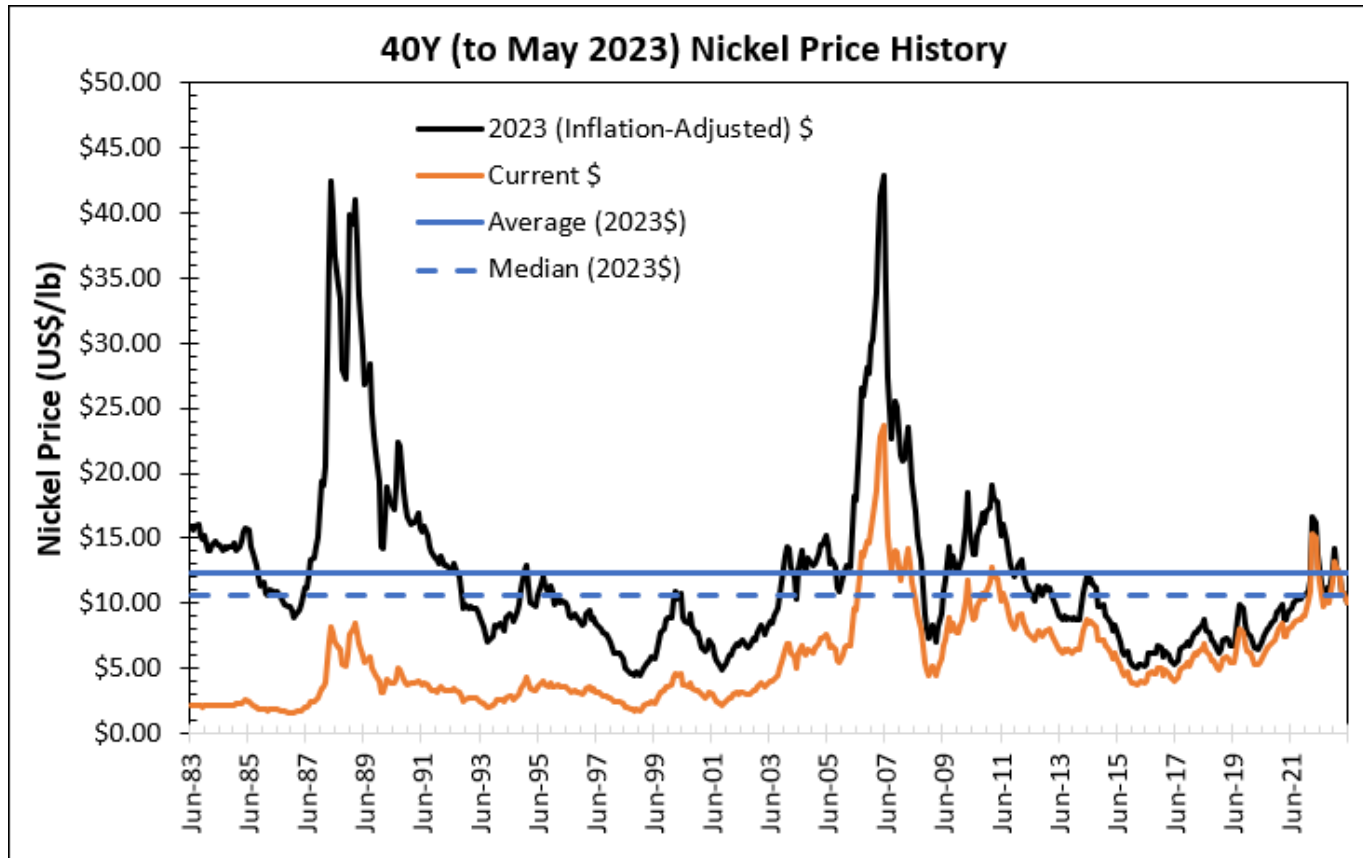

- Orange line represents nominal dollars
- Black line represents 2023 dollars using compounded inflation

# Positive PFS Economics

Analysis	Base Case
Pre-Tax IRR	11.1%
Pre-Tax NPV	\$717 million
Post-Tax IRR	11.4%
Post-Tax NPV	\$574 million

*The post-tax IRR is higher than the pre-tax value due to the impact of the Canadian refundable Clean Technology Manufacturing Investment Tax Credit.*

- **Nickel Price: \$9.75/lb**
- **Cobalt Price: \$26.54/lb**
- **Nickel Payability: 78%**
- **Cobalt Payability: 50%**
- **Discount Rate: 7%**
- **Currency: \$USD**

# Project Sensitive to Nickel Price

Sensitivity Analysis	High Price Case +(15%)	Base Case	Low Price Case -(15%)
Nickel Price (\$/t)	\$24,725	\$21,500	\$18,275
Nickel Price (\$/lb)	\$11.22	\$9.75	\$8.29
IRR (pre-tax)	15.2%	11.1%	6.2%
IRR (post-tax)	14.9%	11.4%	7.1%
NPV (\$M, pre-tax)*	\$1,552	\$717	-\$117
NPV (\$M, post-tax)*	\$1,112	\$574	\$21

\*at 7% discount rate



# Comparison with Indonesian Laterite Projects

## TURNAGAIN SULPHIDE

- Open pit mine in hard rock
- Deep deposit minimizes mine deforestation
- Low erosion potential, pit water used/treated
- Northern location reduces biodiversity impacts



*Gibraltar Copper Mine, BC (Canadian Mining Journal)*

## PROSPECTIVE LATERITE

- Strip mining soft deposits
- Thin deposits increase mine deforestation
- High erosion potential, river/ocean contamination
- Tropical location increases biodiversity impacts



*Nickel Mine in Sulawesi (Chinadialogue.net, Ian Morse)*

# Modern Tailings Management



**Efficient** valley location minimizes dam construction

---



Dam construction by **centerline and downstream methods**

---



Tailings to be sub-aerial (**dry beach**), allowing mineral carbonation

---



**Low seismic risk**

---



Relatively low precipitation (~0.6 m/y), **excellent water balance**

---



**CO<sub>2</sub> sequestration** in tailings through mineral carbonation

---

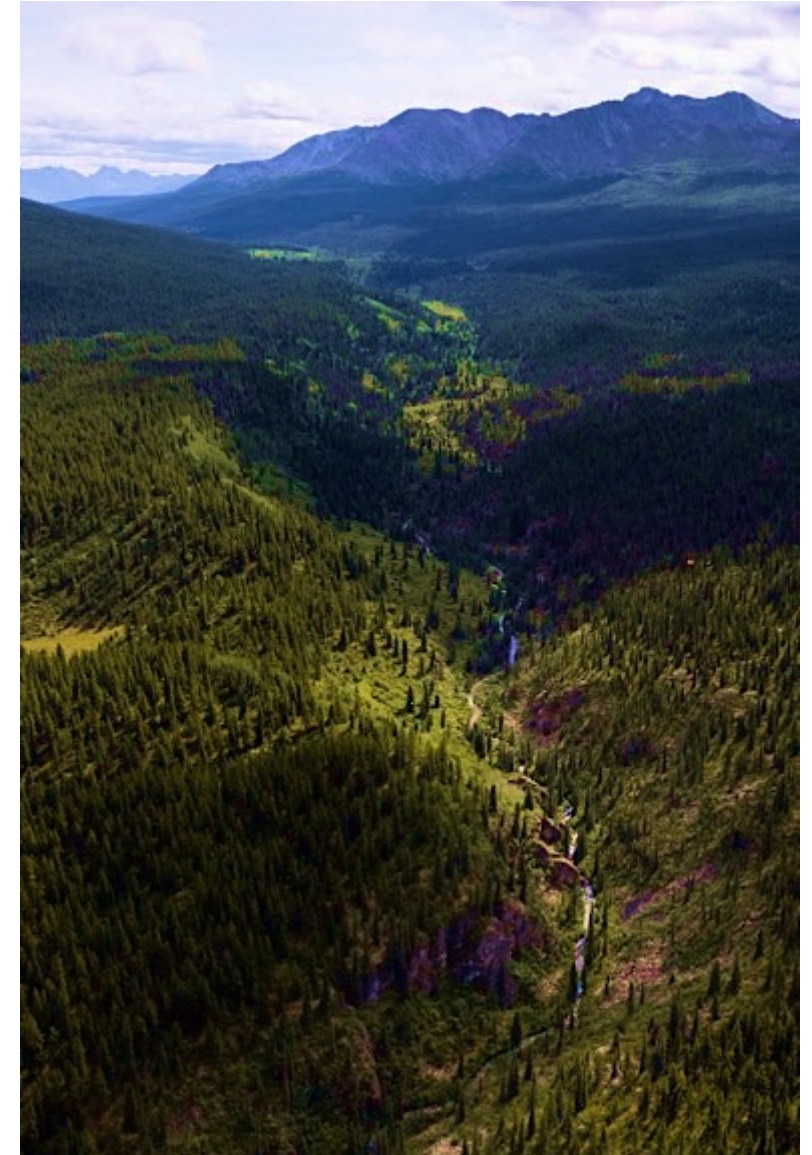



# Engineering - TMF

- TMF valley design for efficiency
- Multiple-accounts alternatives assessment completed
- TMF design includes downstream starter dams
  - Center-line raises and buttresses on main dam
  - Downstream raises on saddle dam
  - No upstream dam construction
- Safe dam operation first priority, then expose maximum tailings surface to air to promote carbon sequestration

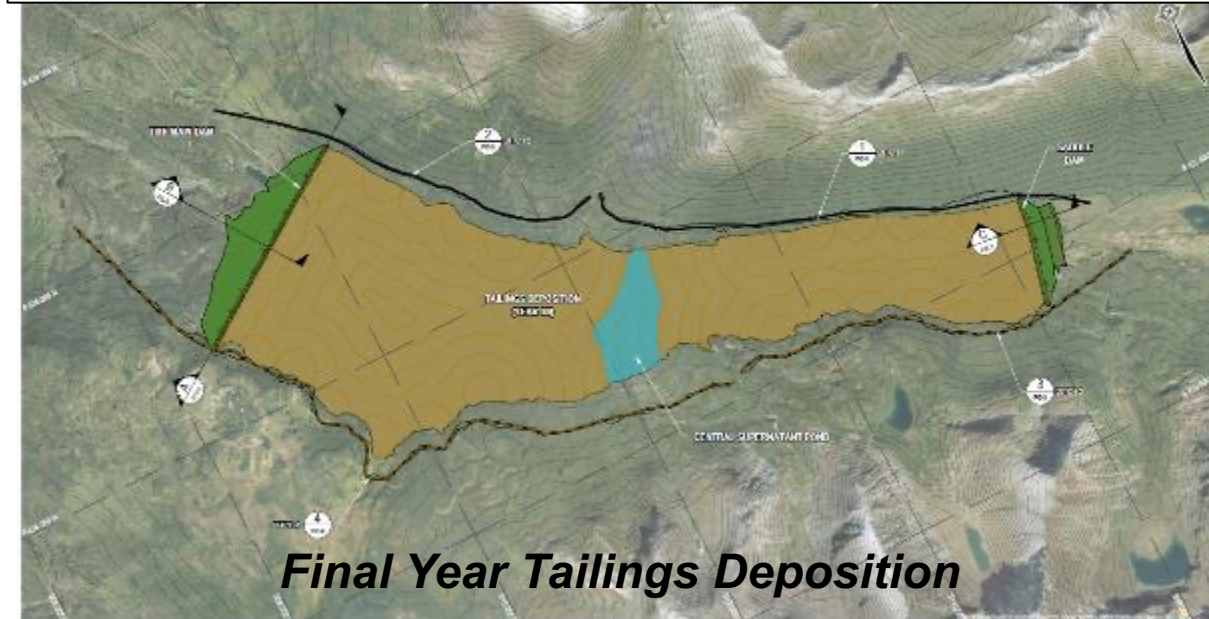
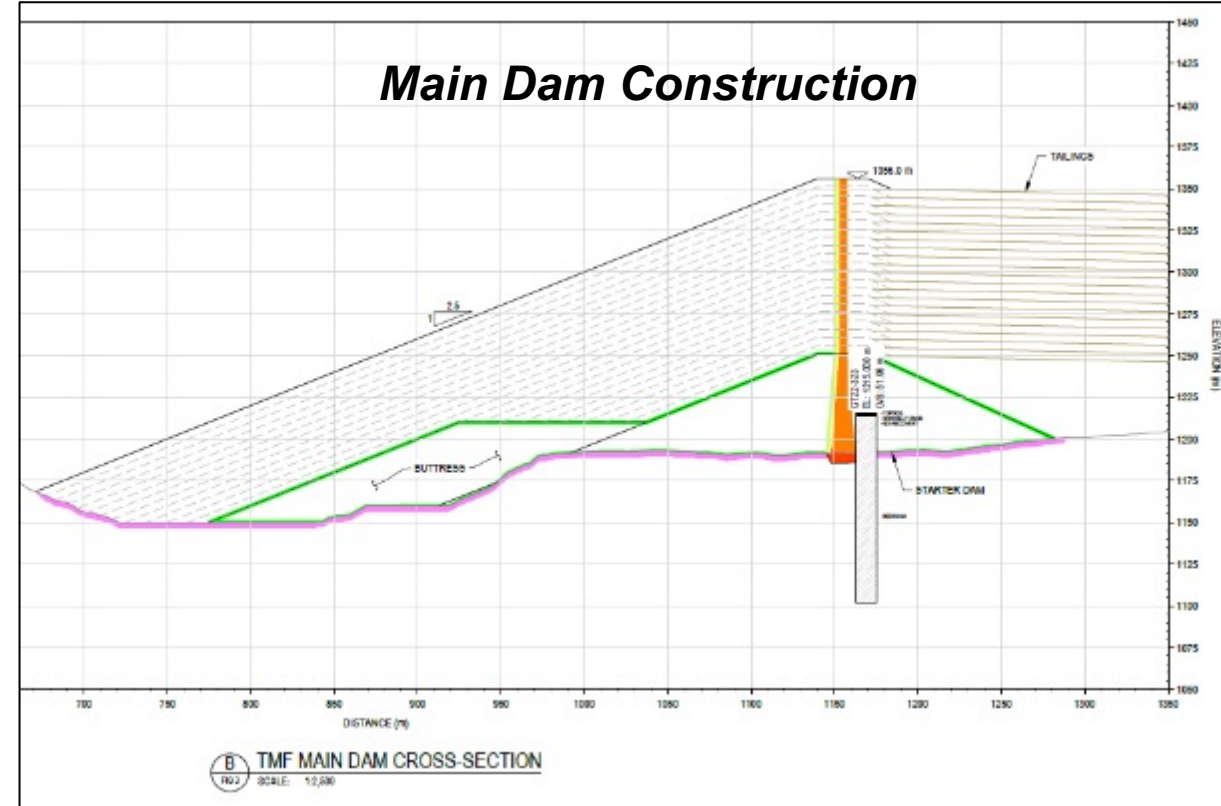

# Carbon Intensity of Nickel Processing

- Sulphide projects have lower carbon intensities
  - Upgrading of ores to concentrates
  - Sulphur is a fuel for smelting
- Laterite processes treat entire orebody with chemical leaching or smelting  
→ higher carbon intensity
- Indonesian supply at top end of CO<sub>2</sub> emissions

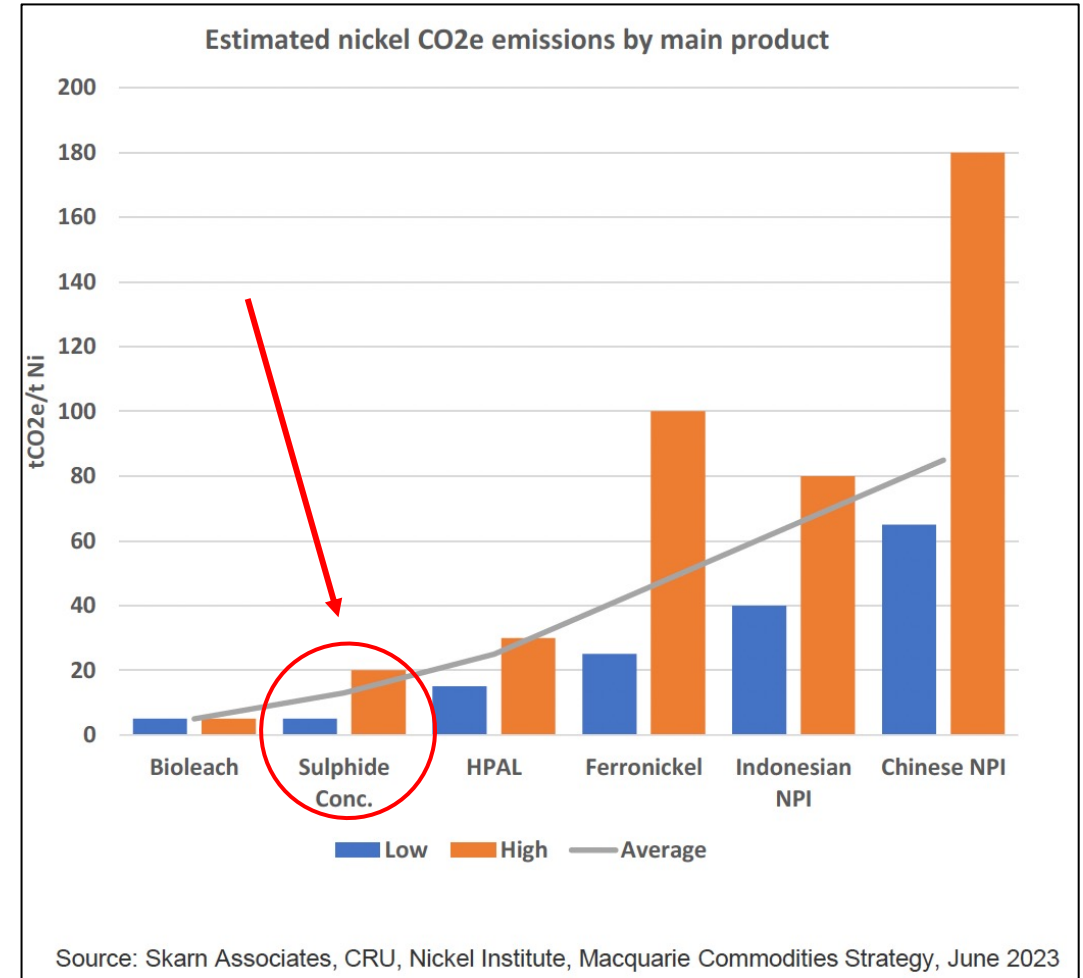



# Carbon Neutrality at Turnagain

- Mine equipment selection reduced carbon intensity
- In addition, CO<sub>2</sub> sequestration in tailings through naturally-occurring mineral carbonation will reduce carbon intensity further
- Transforms the TMF into a permanent carbon mineralization facility
- Testing by Dr. Greg Dipple (University of British Columbia) demonstrated stable reaction rates of 27 to 34 t/ha/y
  - At final TMF area, this reaction rate is 32-41 kt/y

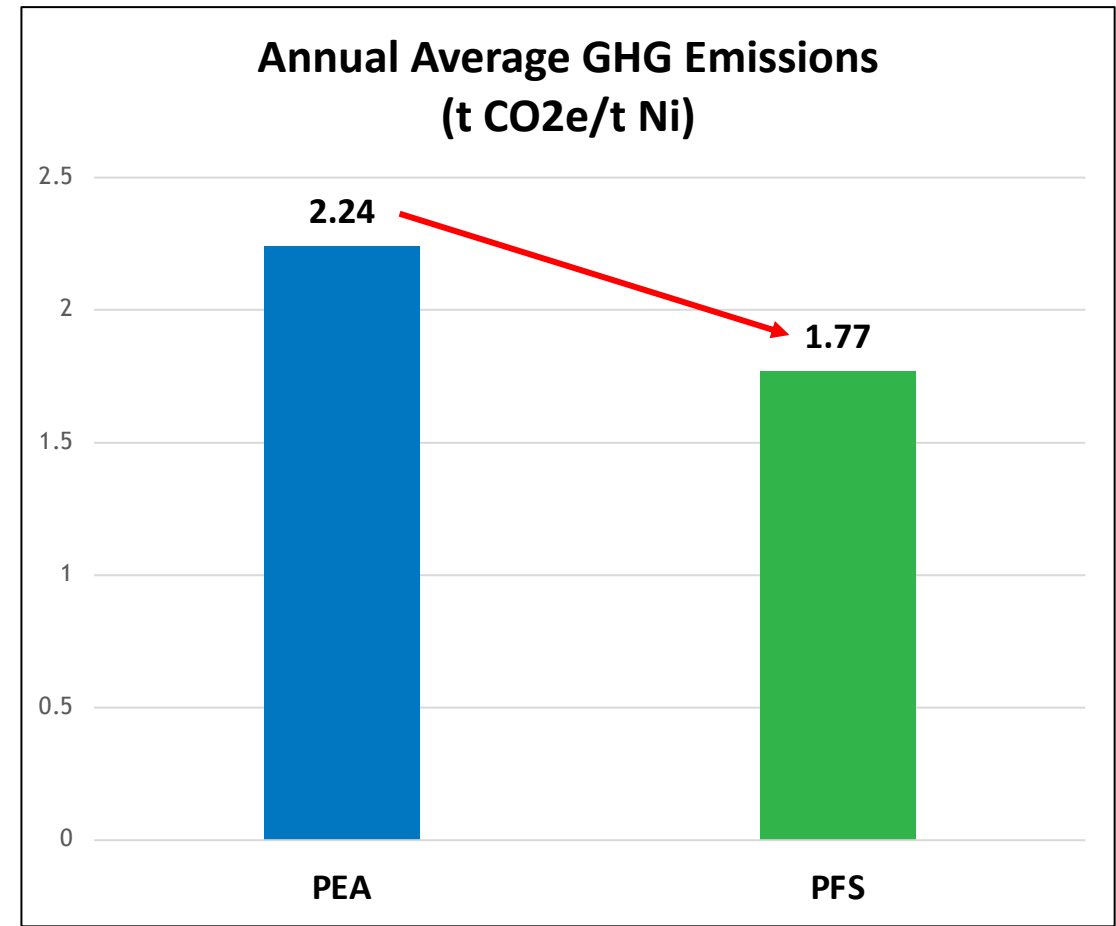

# Plans & Catalysts

**2023**

◆ PFS announced in September 2023

◆ Partnership Discussions



◆ Feasibility Study

◆ Environmental Assessment



◆ Startup



◆ LOM Production average  
35,000 t/y Ni  
2,000 t/y Co



# Board of Directors



**Mark Jarvis, CEO, Chairman of the Board**

Mr. Jarvis has more than 30 years of experience in exploration and development of mineral resources, both in oil & gas and metals. After a career financing exploration projects as a stockbroker, he moved to the corporate side of the business in 1996. He joined the board of Ultra Petroleum as Director and was responsible for Corporate Finance at a time when Ultra had a large unconventional gas prospect that ultimately became 3 TCF of proved reserves.



**Robert Morris, Director**

Mr. Morris is a former senior executive with Vale S.A., the largest nickel producer in the world, most recently as Executive Vice President with global accountability for sales and marketing of Vale's base metals portfolio, including Nickel, Copper, Cobalt and Precious Metals. He was an officer of the company and member of the senior management committee. His knowledge of the rapidly evolving market for nickel and cobalt products is extensive and includes marketing battery materials to battery manufacturers.



**Martin Vydra, P.Eng., President & Director**

Mr. Vydra is a former executive with Sherritt International. Martin is widely recognized as an expert in nickel and cobalt extraction, processing and refining including the development and application of advanced technologies to maximize the recovery of valuable metals such as nickel and cobalt from a variety of feeds. While at Sherritt, his technical accomplishments spanned four continents and over 20 operations.



**Lyle Davis, P.Eng. MBA, Director**

Mr. Davis is a director and CEO of Condor Resources Inc., a copper and gold exploration company active in Latin America. He previously worked in the corporate finance practices of Ernst & Young, and in a similar capacity at C.M. Oliver, a brokerage firm. Before that, Mr. Davis was with the Vancouver Stock Exchange. He is a member of the Association of Professional Engineers, Geologists and Geophysicists of Alberta.

# Capital Structure

## Trading Symbols

TSX.V: GIGA | OTCQX: GIGGF | FSE: BRR2

## Capital Structure *(January 30, 2024)*

Shares Outstanding	97,904,128
Total Warrants	28,372,224
Free Trading Warrants <small>GIGA.WT, strike price \$0.60, exp. Apr. 23, 2024</small>	13,667,755
Free trading warrants <small>GIGA.WT.A, strike price \$0.45, exp. Feb. 8, 2025</small>	12,075,700
Options	9,255,000
Fully-diluted	135,531,352
Share Price <i>(April 19, 2024)</i>	C\$0.20
Market Capitalization	C\$20M

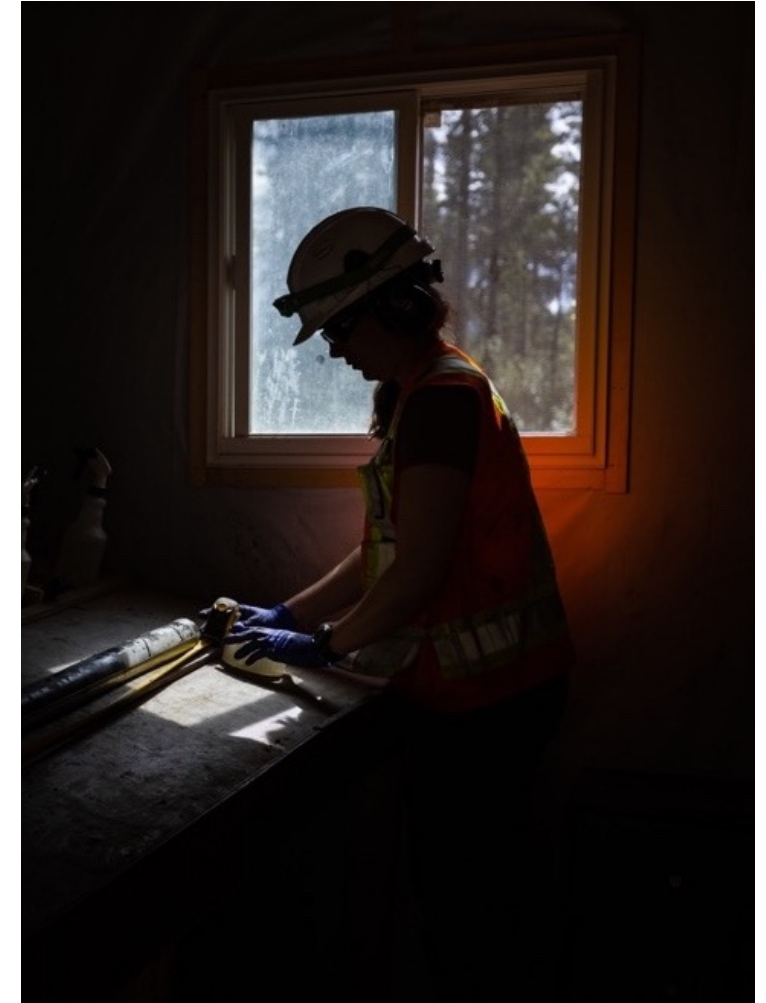





**Where will all the nickel come from?**



# Let's Talk.

Visit us: [www.gigametals.com](http://www.gigametals.com)

Email: [ashapiro@gigametals.com](mailto:ashapiro@gigametals.com)

Call: +1 (604) 681-2300

*Suite 203 – 700 West Pender Street  
Vancouver, British Columbia  
Canada, V6C 1G8*



TSX.V: GIGA | OTCQX: GIGGF | FSE: BRR2

